

No.	Part Name	Material	Process-Remark
1	Dome Cover	PC(Clear)	With a Protection Film
2	Case Upper	ADC12	
3	Top Cover Lock Screw	Stainless Steel	
4	Case Lower	ADC12	
5	Name Plate	Polyester Film	
6	MAC Address Label		
7	Serial No. LABEL	Polyester Film	
8	NTSC/PAL Switch		
9	INITIAL SET Switch		
10	ACT LED		
11	LINK LED		
12	SD MOUNT LED		
13	SD ERROR/AF LED		
14	WIDE Switch		
15	TELE Switch		
16	AF Switch		
17	MONITOR OUTPUT Jack		
18	DC 12V INPUT Terminal		
19	SD CARD Socket 1		
20	SD CARD Socket 2		
21	SD ON/OFF Switch		
22	Support wire for installation	SUS304	
23	Wall Fitting Screw		
24	Attachment Assy		
25	RJ-45 Connector		
26	MIC/LINE INPUT Jack		
27	AUDIO OUTPUT Jack		
28	EXT I/O Connector		
29	Data Matrix Label	Polyester Film	
30	Terminal Label	Polyester Film	
31	EXT I/O Label	Polyester Film	
32	I/O No. Label	Polyester Film	
33	Open-Lock Label	Polyester Film	
34	Cap Mid Case		

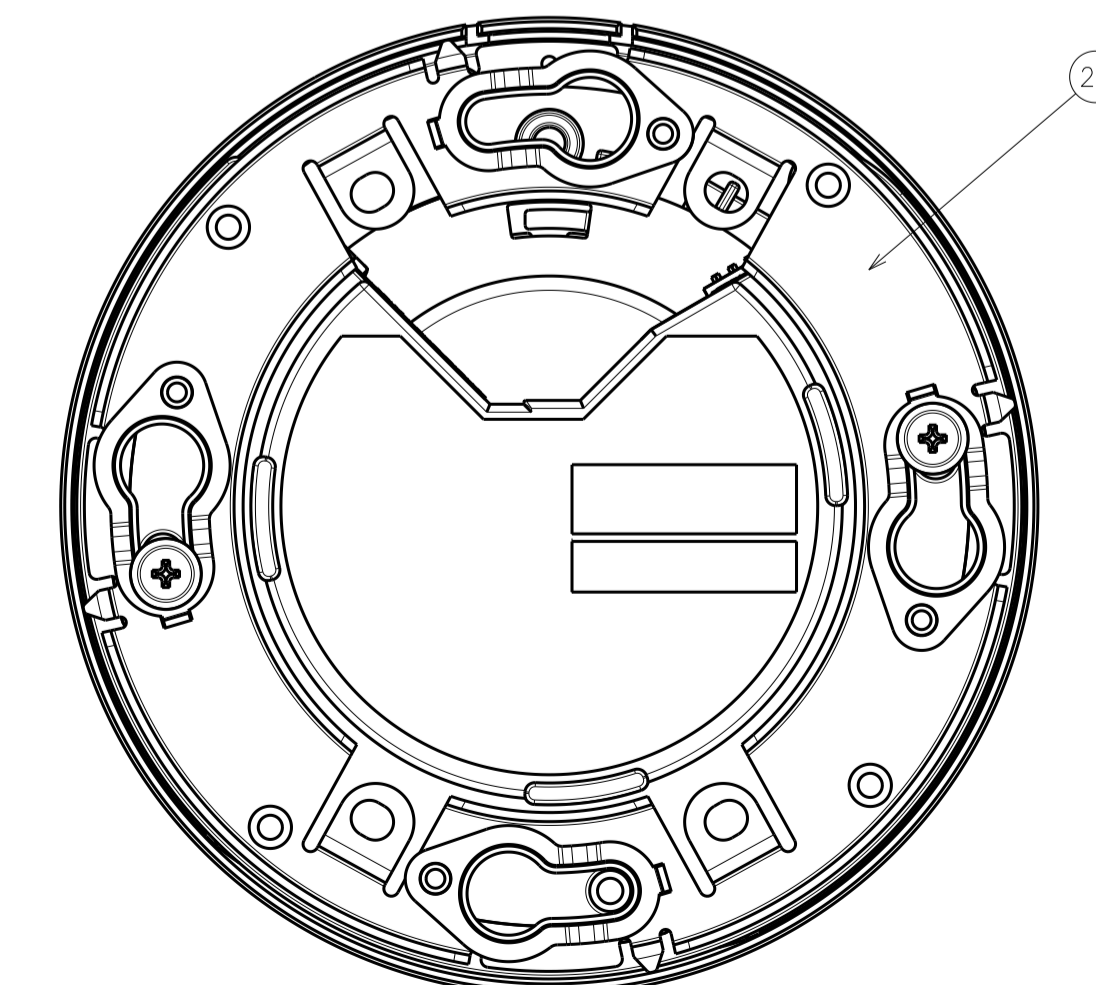
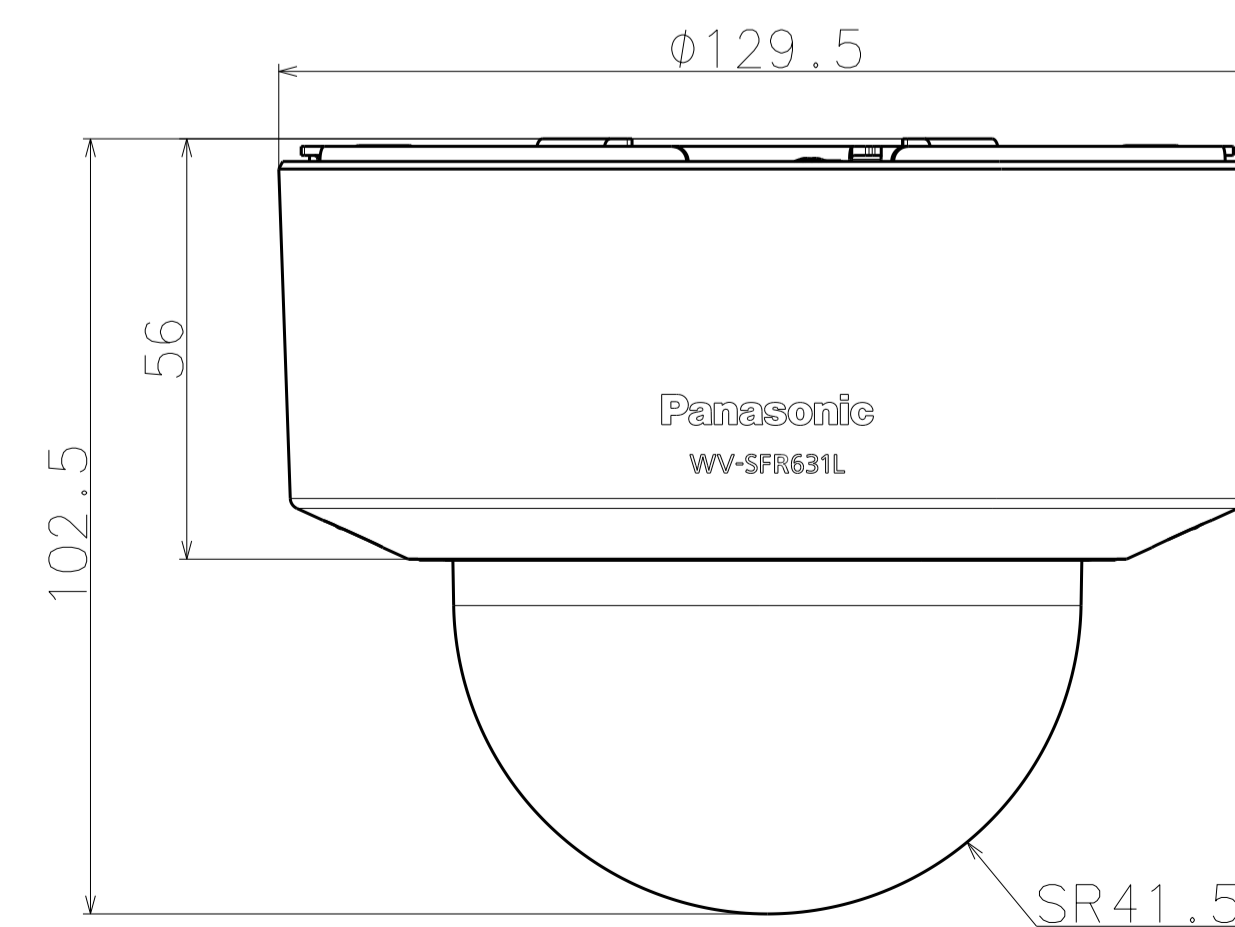
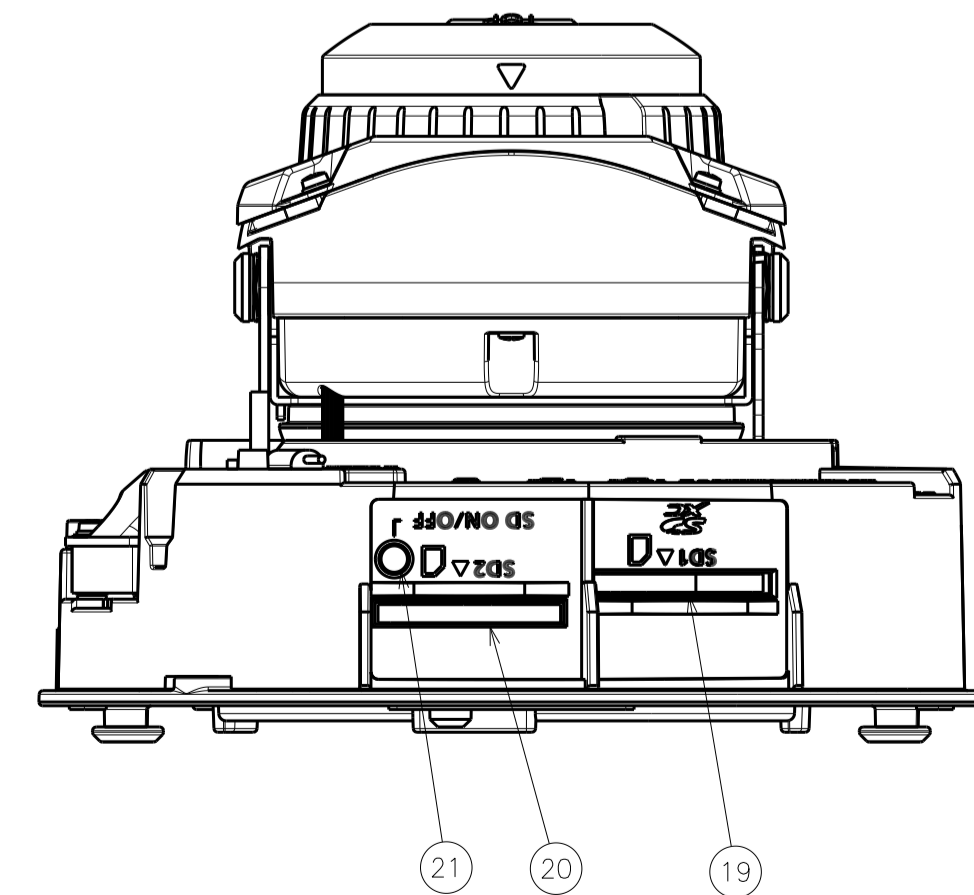
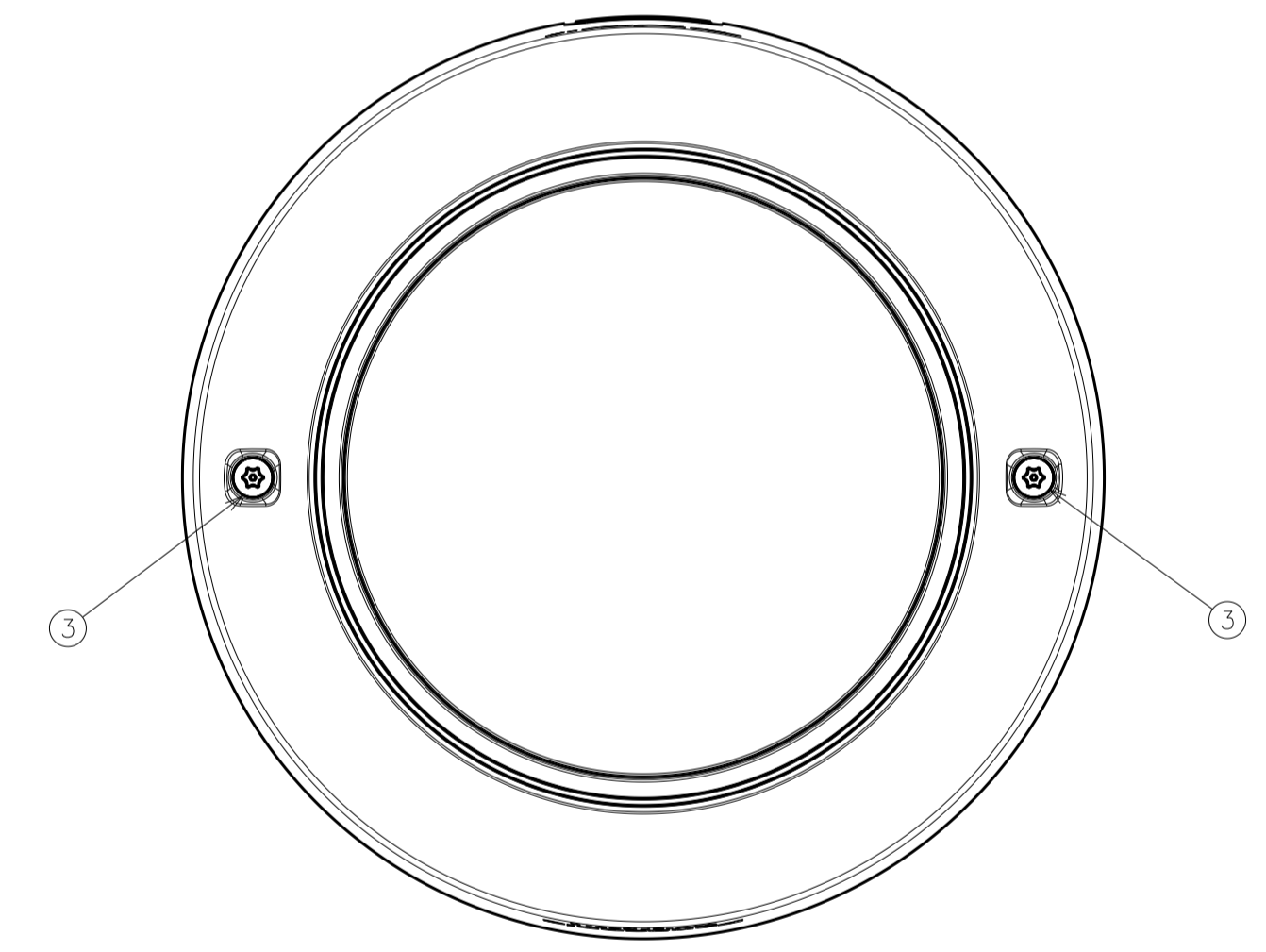
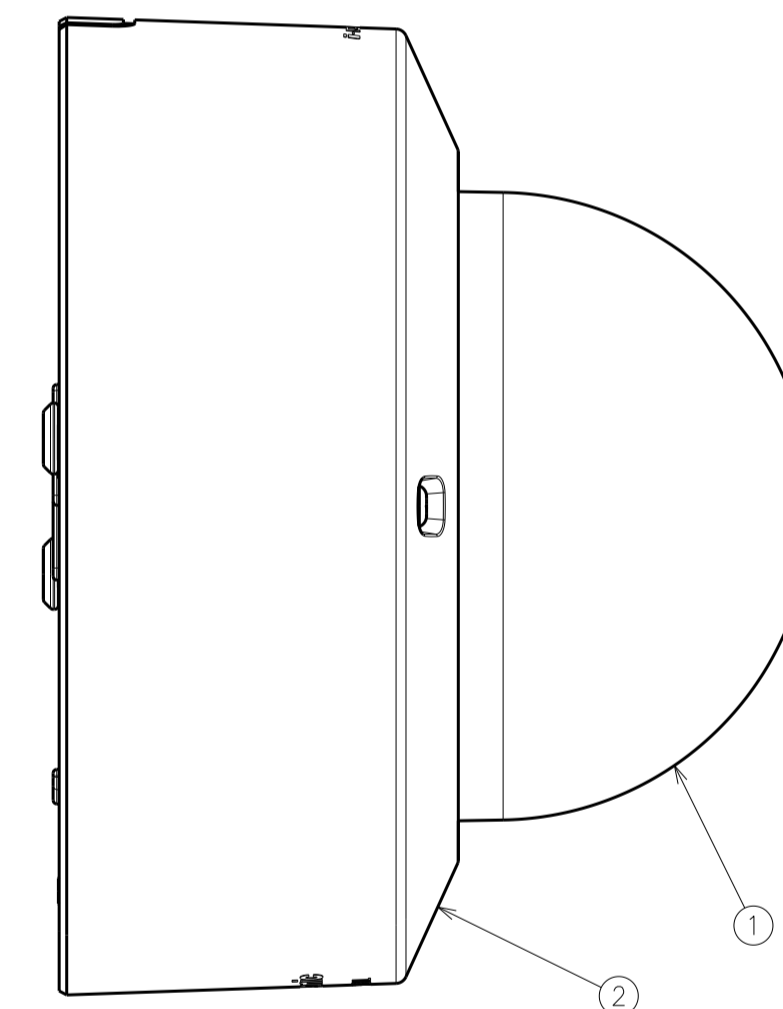
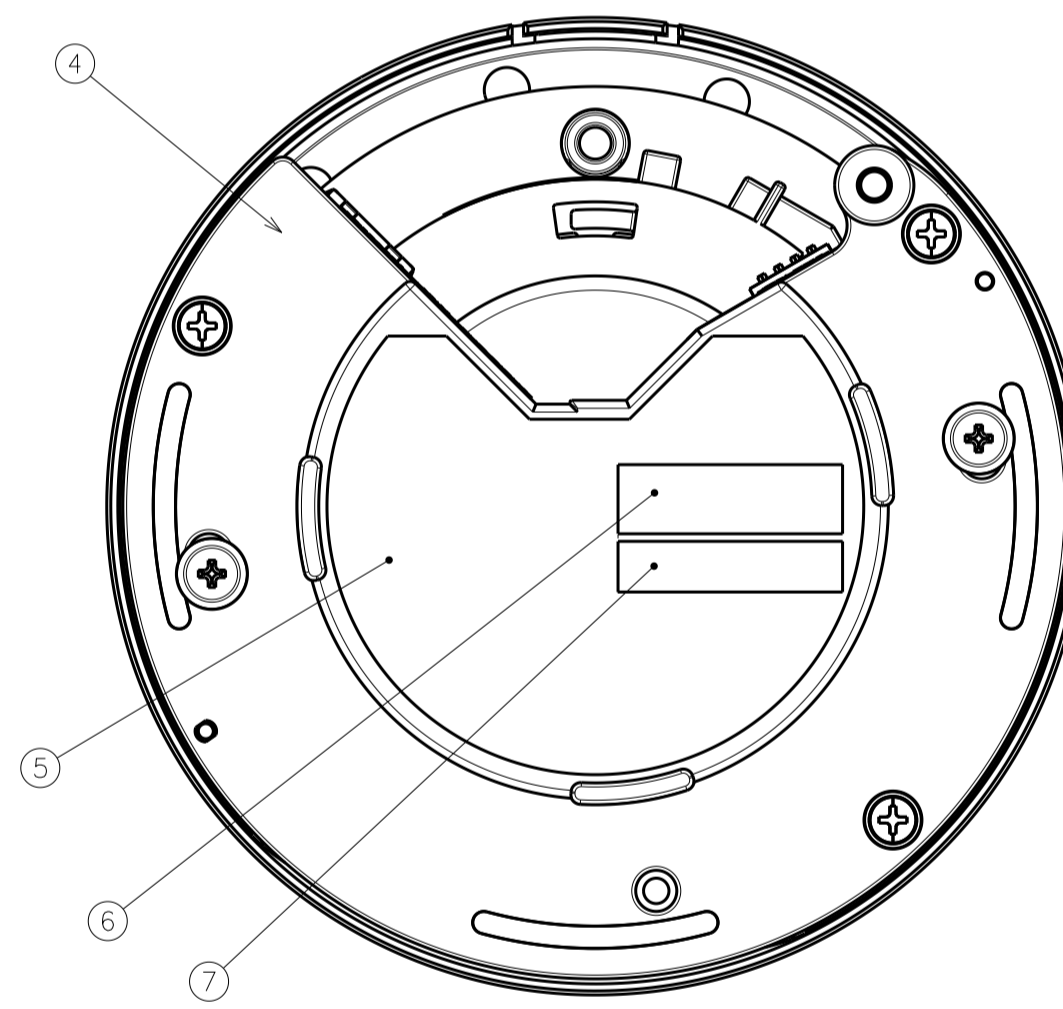
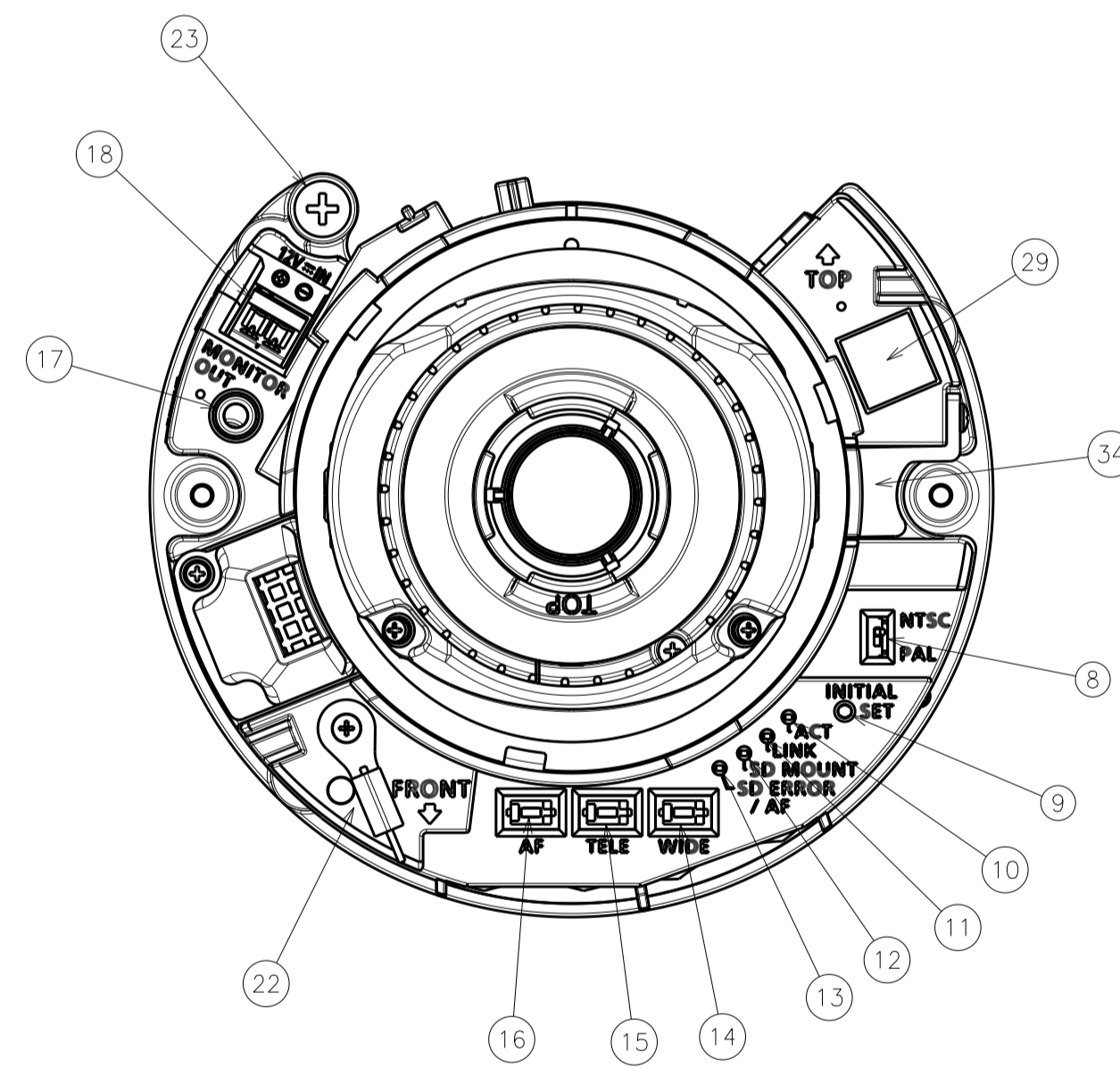
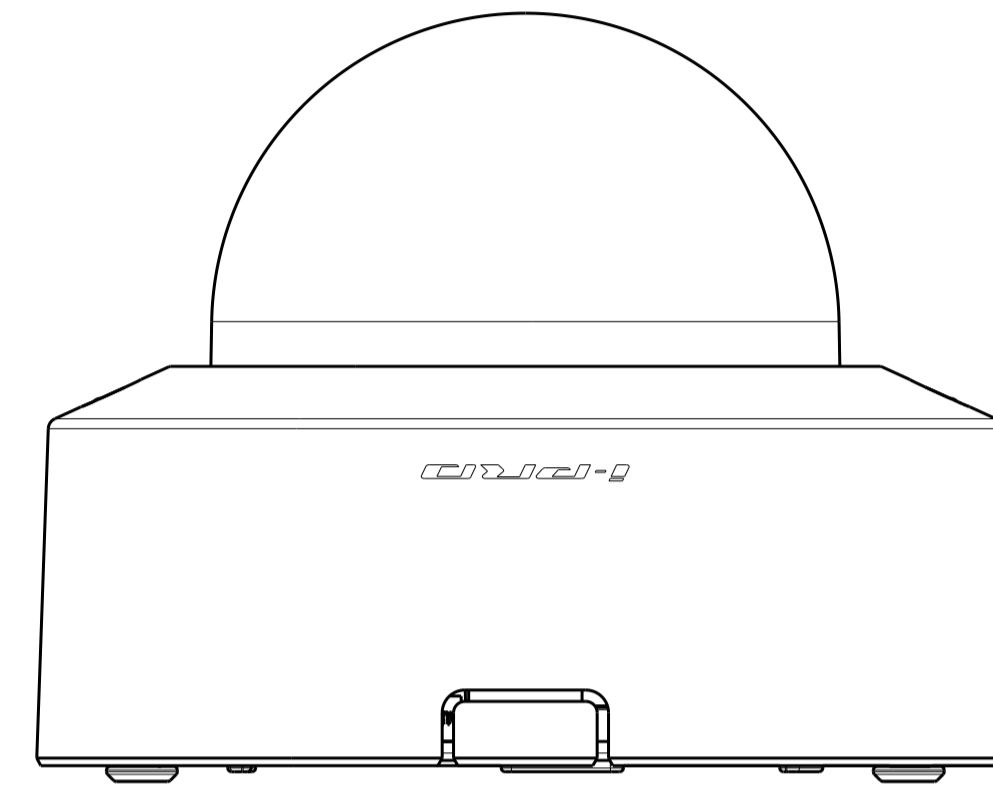
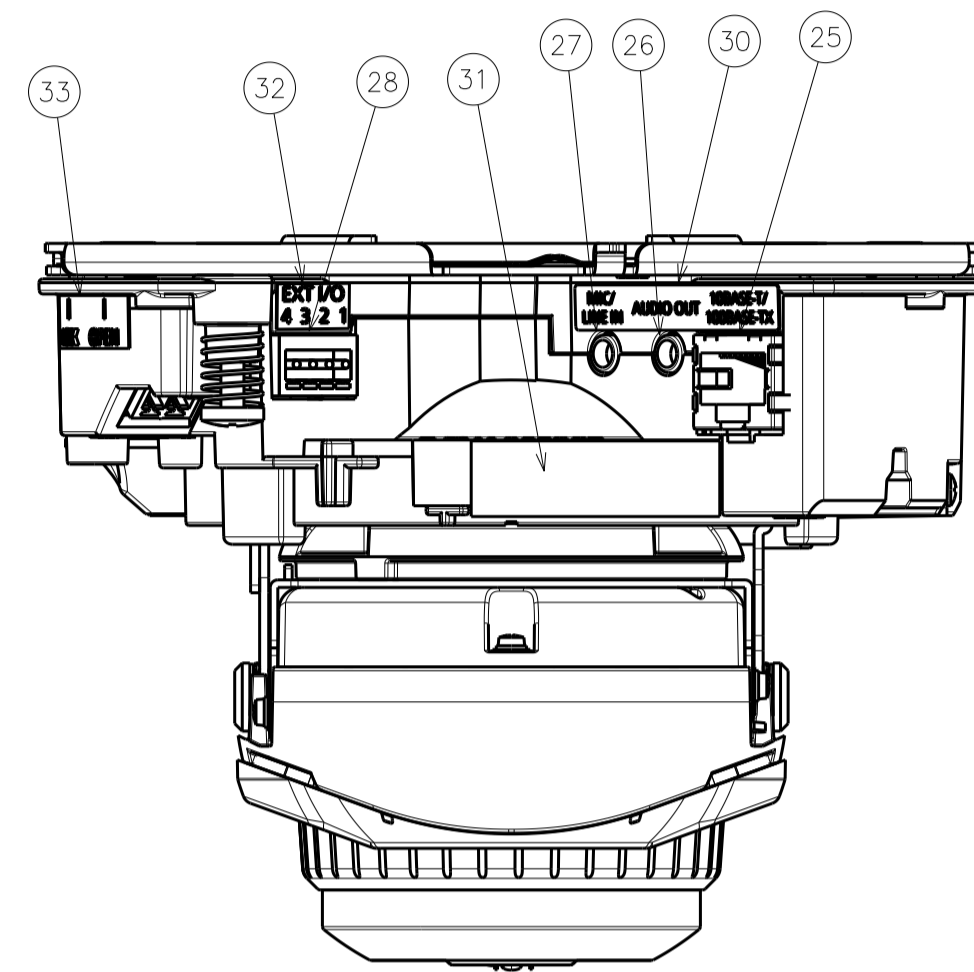

With Attachment Plate

Model WV-SFR631L