

・パナソニックグループ化学物質管理ランク册計最新版(製品版)を遵守すること。
 URL:http://panasonic.co.jp/eco/topics/suppliers/
 ・Observe the Panasonic Group Chemical Substances Management Rank Guidelines
 latest version (For Products).
 URL:http://panasonic.net/eco/topics/suppliers/

SYM.	DATE	REVISION	SIGNED	CHECKED
△				
△				
△				
△				

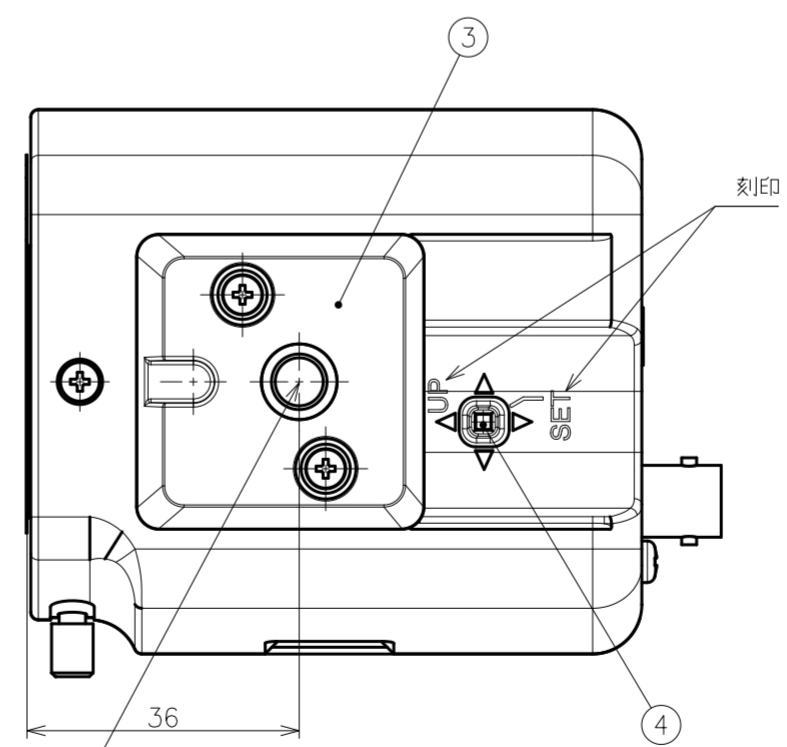
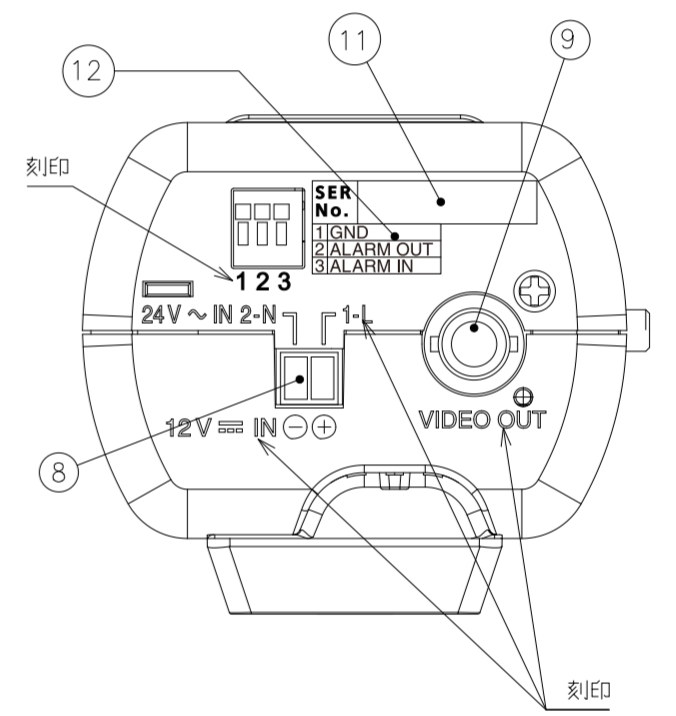
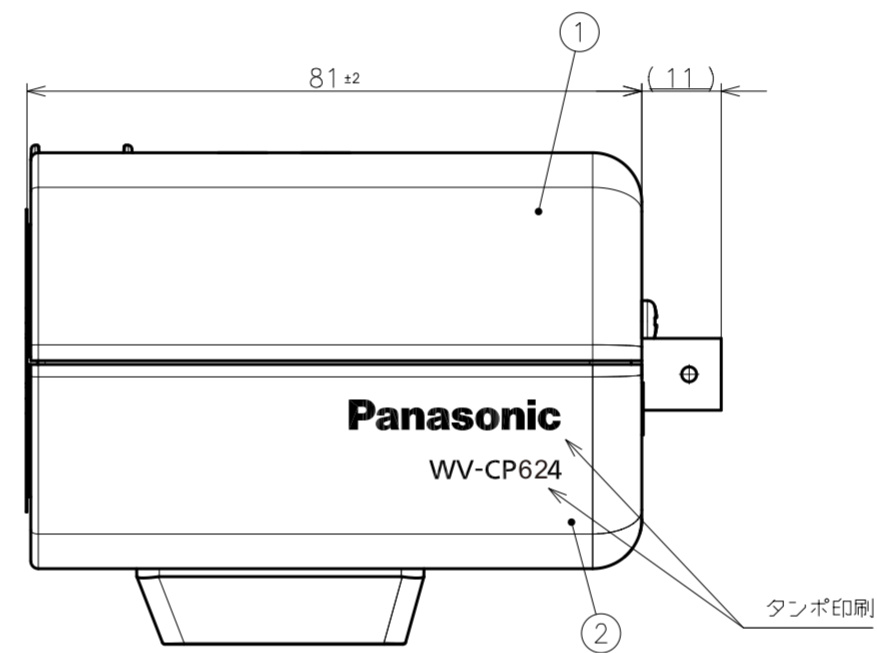
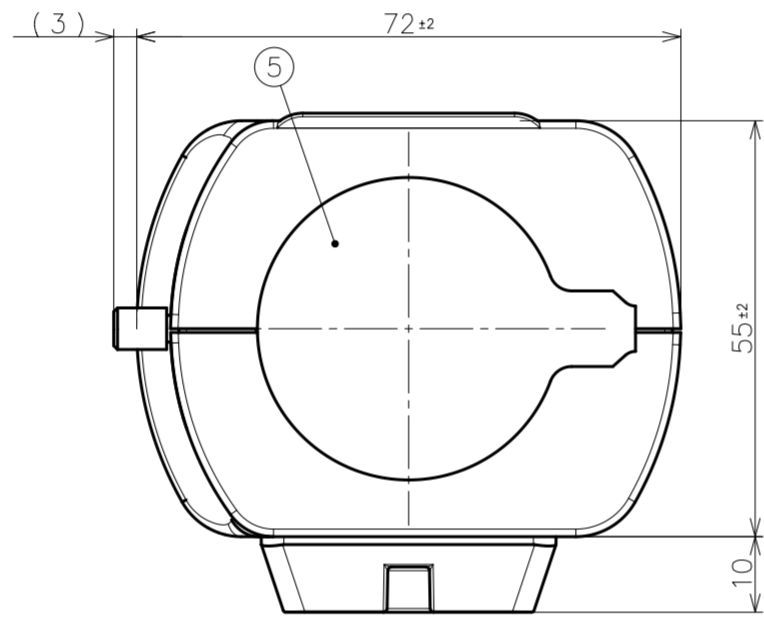
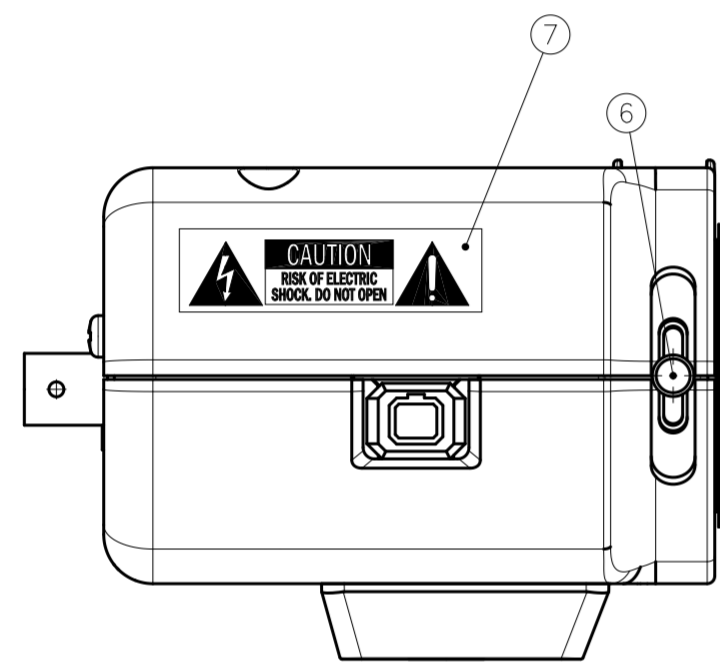
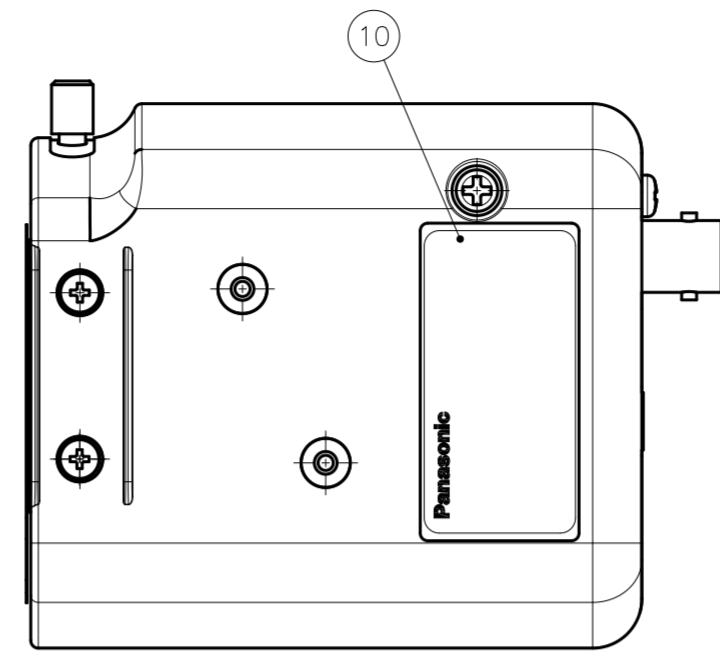

1/4-20UNC for Tripod
(Depth 10mm)

SYM.	ITEM OR PARTS No.	NAME	QTY	MATERIAL & SIZE	TREATMENT	REMARK
12		Alarm label	1	Poryester Film		
11		Serial Number label	1	Polyester Film		
10		NAME PLATE	1	Polyester Film		
9		VIDEO OUT Connector	1			
8		Power Supply Terminal	1			
7		CAUTION LABEL	1	Polyester Film		
6		FB LOCK SCREW	1	SWCH		
5		LENS MOUNT LABEL	1	PP FILM		
4		JOG SW CAP(Camera Set Up)	1	ABS (V-0)		
3		TORIPOD ATTACHMENT	1	ABS/PC (V-0)		
2		LOWER CASE AC24V	1	ABS (V-0)		
1		UPPER CASE AC24V	1	ABS (V-0)		

REMARK		MATERIAL & SIZE		PROCESS		MODEL	NAME
SCALE	DESIGNED	DRAWN	CHECKED	APPROVED	Weight: APPROX,150g	WV-CP624E	箱入規格/Main Assembly Standards <外観図>
1:1	M.Shimada 2011.11.02	J.Hirako 2011.11.02	Shimada				Page M-Mb1 of M-Mb1
REF.NO.	ISSUE 1-1				1		